

Varenummer: 4395000401
Beskrivelse: Rota-fix spændelement F40x75
Rustfast stål

Mål

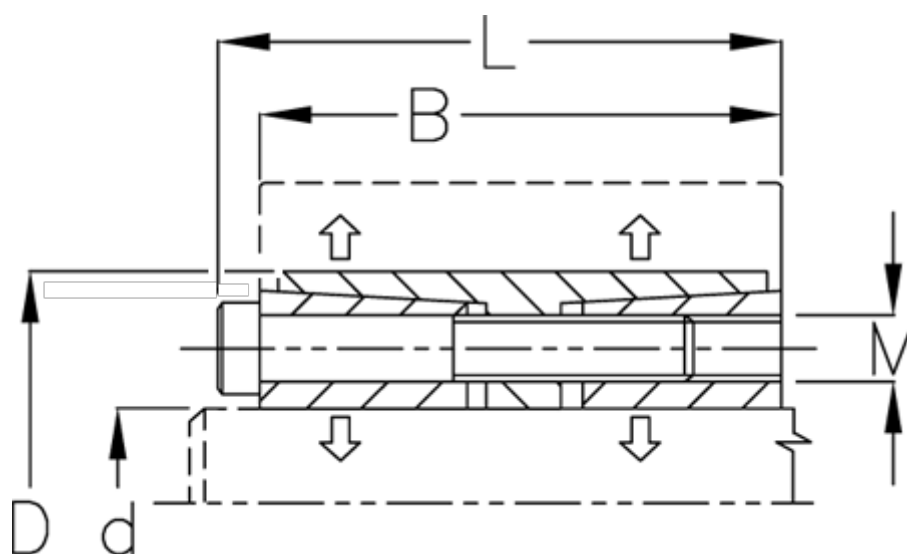

B mm	= 54
d H8 mm	= 40
D mm	= 75
F kN aksialkraft	= 76.7
L mm	= 62
M mm	= M8
Overfladeruhed	= R? ? 3.2 μ m
P N/mm ² fladetryk på aksel/nav	= 38

T Nm drejningsmoment	= 1530
Tolerance	= Aksel h8, Nav H8
Ts Nm boltetilspændingsmoment	= 28.7